

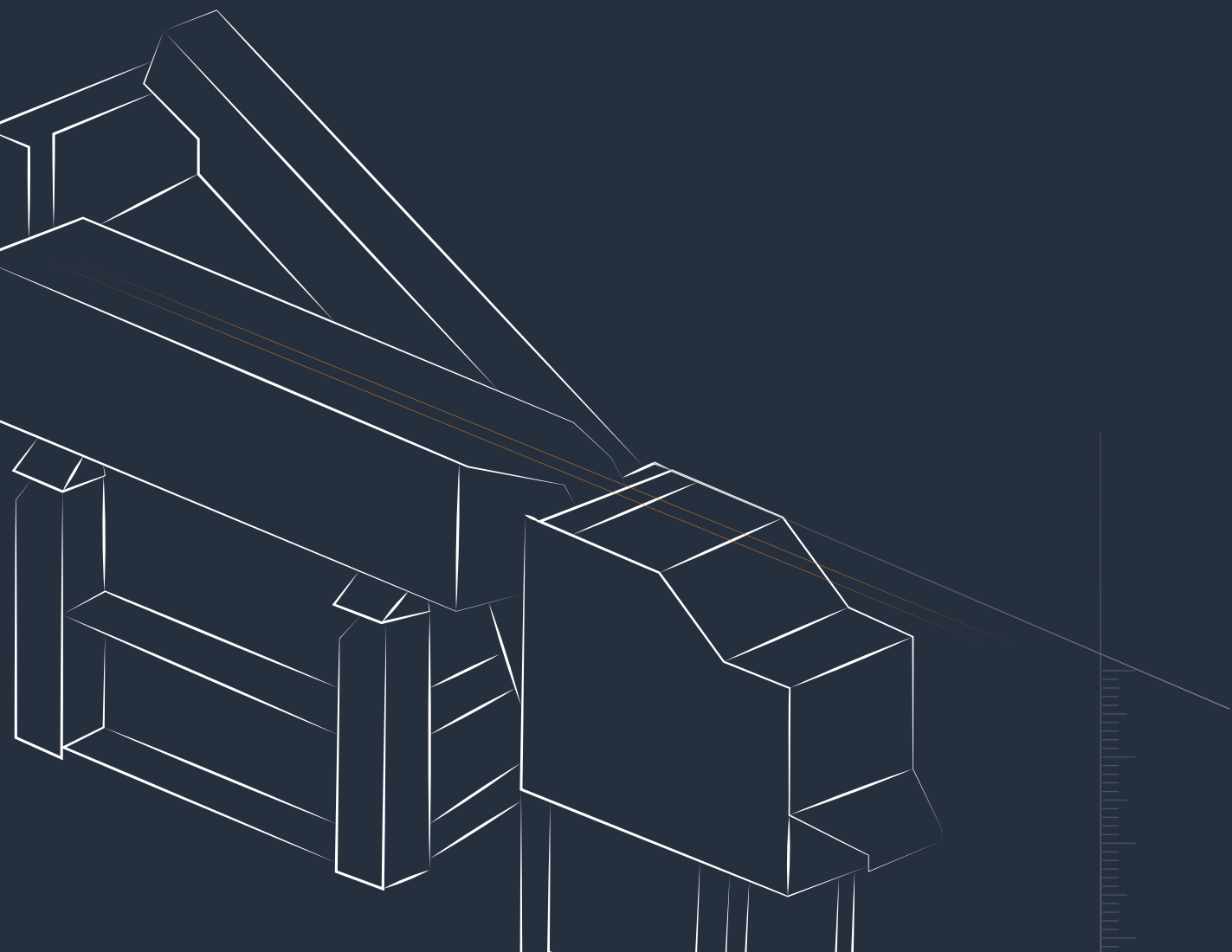

# Linear, continuous feed systems



## Mass Finishing



High-performance equipment and innovative technologies – productive and cost-effective

## Shot Blasting

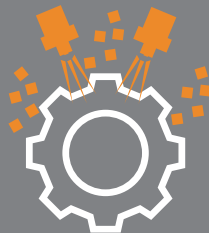

Customer-oriented equipment technology and intelligent process solutions – long-lasting and energy-efficient

## AM Solutions



Comprehensive solutions for additive manufacturing, especially 3D post processing equipment

› **80**

More than 80 years of **experience**



**15** locations –  
over **150** distributors –  
over **1,500** employees across the globe



Worldwide **Customer Experience Center**



More than **15,000**  
**different types of media and compounds**

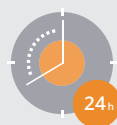

Our technical service –  
**round-the-clock support**



**Transfer of professional knowledge**  
by certified trainers

## Table of contents

Linear, continuous feed technology – mass finishing at its best	4 - 5
The processing unit - perfectly engineered for optimum finishing results	6 - 7
Efficient operation guarantees low costs	8 - 9
Gentle and reliable separation of high value work pieces	10 - 11
High productivity and easy maintenance	12 - 13
“Intelligent” controls guarantee trouble-free operation	14 - 15
“IA flexible equipment concept – based on creativity and knowhow	16 - 17
Automation saves costs	18 - 19
Top performance – with a small footprint	20

# The new continuous feed vibratory systems – Leave your work piece finish in our hands

In today's manufacturing environment continuous feed vibratory finishing is increasingly becoming the preferred processing method for high volumes of small to midsize work pieces. Among the reasons for this development are certainly the innovative equipment designs from the Rösler engineers

paired with a wealth of surface finishing knowhow and the high Rösler quality standards. The result – equipment designs that are recognized all over the world and by far the largest market share in continuous feed vibratory finishing systems.

### That's how it works

Within predetermined time intervals raw work pieces are continuously feed into a U-shaped rectangular processing bowl filled with grinding or polishing media. One sidewall of the processing bowl is curved. The induced vibratory energy causes the work pieces to continuously rotate in the media mass and, at the same time, move forward. Parameters including processing time and the desired grinding or polishing effect can be controlled by adjusting the processing bowl inclination, the imbalance weights and the RPM of the vibratory drive. After one single pass throughout the complete length of the processing bowl the finished work pieces are separated from the media in an external vibratory separation unit. At the same time, the work pieces can also be rinsed off, before they are transferred to the next processing station, for example, a dryer. The media is then returned to the processing bowl with a combined vibratory/ conveyor belt transport system.

### Fields of application

Deburring, surface grinding, edge radiusing, polishing and ball burnishing of stampings, castings, forged and machined work pieces with the powerful linear, continuous feed vibratory systems. With their high throughput and cost efficiency coupled with a high degree of automation they attract more and more customers.

# LINEAR, CONTINUOUS FEED TECHNOLOGY –

## Mass Finishing at its best

The superior equipment concept of the Rösler linear continuous feed systems is based on the fact that all components are developed and manufactured in-house. The ultra modern machine building division, different processing bowl sizes, the

sturdy vibratory drive, the separation station with large screens and state-of-the-art controls guarantee absolute equipment reliability under the most challenging operating conditions.

### 1 Processing bowl

- ▶ The strengthened weldment is designed to withstand the most severe vibratory loads
- ▶ heat treated for stress relief
- ▶ Lined with wear resistant rubber or polyurethane (optional)
- ▶ Feeding of the process water over the complete length of the processing channel
- ▶ Discharge of the process water through multiple large bottom drains that can be removed and replaced from the outside

### 2 Media return

- ▶ Inlet chute – firmly attached to the processing bowl – for return of the grinding or polishing media. The media return system does increase the operating length of the processing bowl resulting in an additional operating capacity
- ▶ Gentle media return into the processing bowl with low drop heights, also suitable for use with ceramic media

### 3 Special discharge section

- ▶ The design of the discharge section at the exit of the processing bowl is based on fluid mechanics and can be adapted to different finishing tasks as well as work piece shapes, sizes and weights.
- ▶ The discharge section is equipped with a patented media unload gate

### 4 Change of media

- ▶ In case of a required media change the discharged media is returned to a media bin with a special belt conveyor (optional)

### 5 Vibratory drive system

- ▶ Powerful Rösler vibratory drive
- ▶ Adjustable imbalance weight units equally distributed over the entire length of the processing bowl
- ▶ Electronically controlled supply of the imbalance units with grease (automatic greasing)

### 6 Inclination of the processing bowl

- ▶ The processing bowl is placed on four air cushions made from rubber, thus insulating the surrounding area from induced vibrations
- ▶ Process time can be adjusted between 4 and 30 minutes by inclining the processing bowl using air cushions
- ▶ Reduced noise emissions

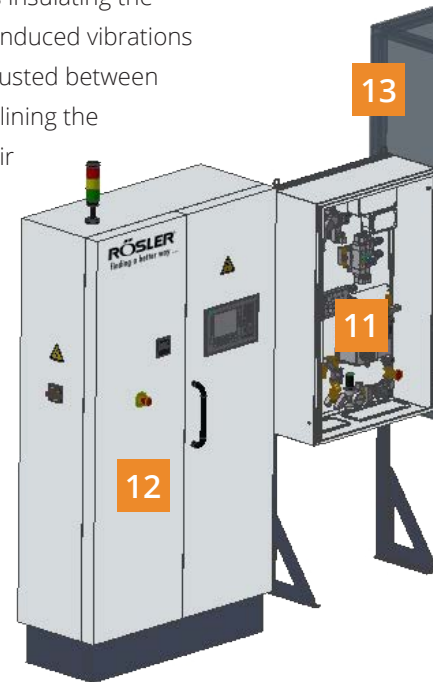

### 7 Base frame

- ▶ Torsion-resistant, stress relieved and sturdy welding construction
- ▶ Base frame placed on vibration absorbing special supports

### 8 Vibratory screening machine

- ▶ Adjustable imbalance units; speed of vibratory drive controlled by frequency inverter (optional)
- ▶ The multi level screens can be quickly replaced without the requirement for special tools
- ▶ Single level screen deck (optional)
- ▶ Integrated undersize media classification screen
- ▶ Optional: Magnetic separation
- ▶ Optional: Inverse screen separation

## 9 Media classification

- ▶ Permanent discharge of undersize media
- ▶ The screen insert in the vibratory separation unit can be quickly exchanged
- ▶ Polyurethane flapper screen or bar screen (optional)
- ▶ Integrated discharge of the rinse water with collection tray

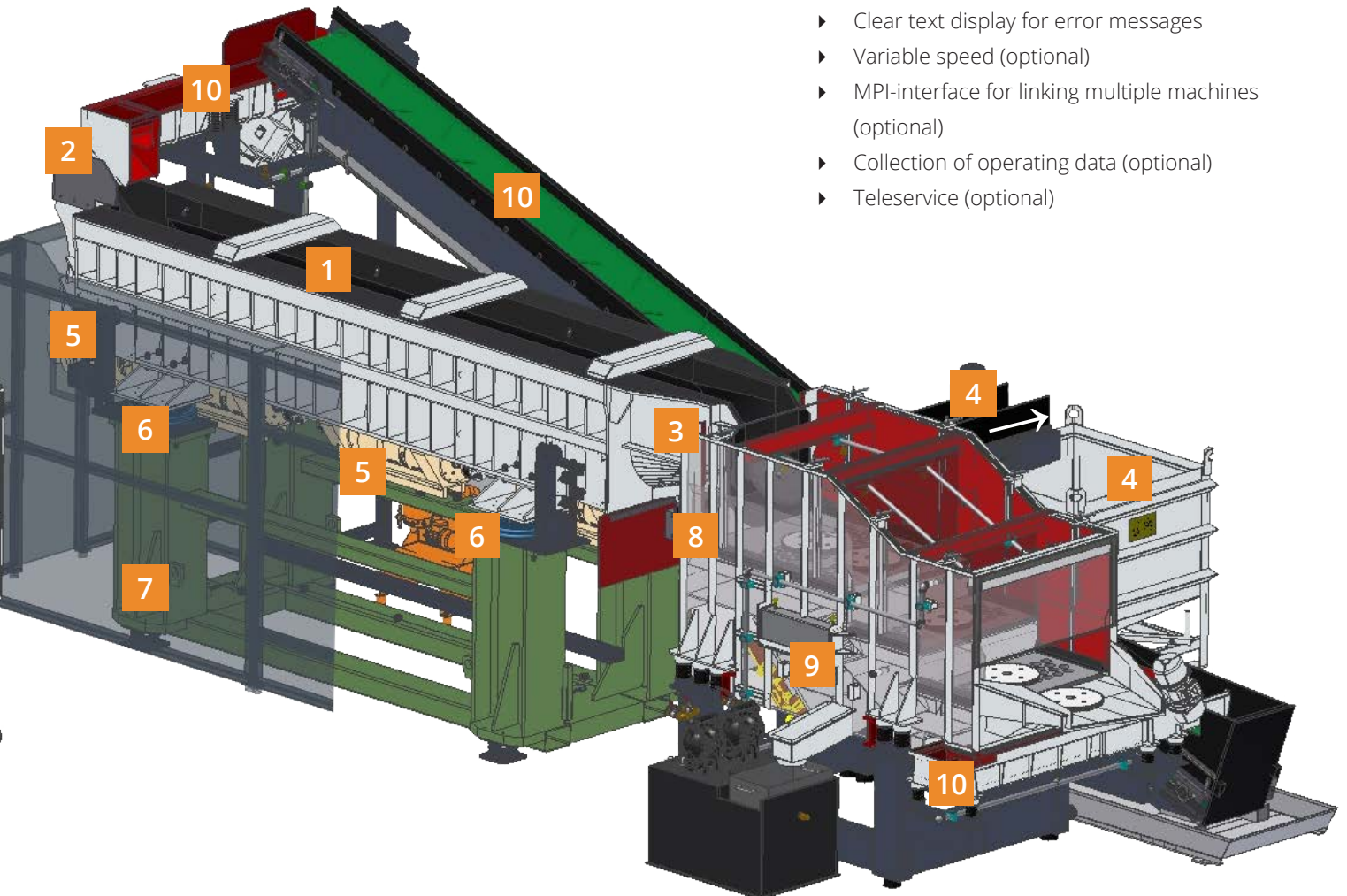

## 12 Easy to operate equipment controls

Fully automatic operation with modern PLC

- ▶ Multiple processing programs
- ▶ Clear text display for error messages
- ▶ Variable speed (optional)
- ▶ MPI-interface for linking multiple machines (optional)
- ▶ Collection of operating data (optional)
- ▶ Teleservice (optional)

## 10 Media transport system

Media transport system easily adjustable to different media shapes, sizes and quantities, consisting of the following components:

- ▶ Vibratory cross conveyor built into the separation unit equipped with drain for discharge of residual water
- ▶ Media return conveyor belt equipped with collection tray and exhaust pump for removal of residual water
- ▶ Vibratory cross conveyor at the entrance of the processing bowl

## 11 Handling of process water/pneumatics

- ▶ Central distribution of process water and compound
- ▶ Control of the rinse station
- ▶ Control of the air cushions for inclination of the processing bowl
- ▶ Control valves for the supply with process water

## 13 Safety enclosure

- ▶ Maintenance friendly and easily dismantable enclosure with inspection doors; in full compliance with accident prevention rules and regulations
- ▶ Platform for easy access to the processing bowl (optional)

## Noise reducing cabins

- ▶ Available as special equipment. Design per conditions at customer site

## THE PROCESSING UNIT – perfectly engineered for optimum finishing results

The processing bowl is at the center of the linear continuous feed vibratory systems. The special U-shape of the processing bowl – with one sidewall rounded – is the result of many ye-

ars of research and development. Differently shaped discharge sections at the bowl exit expand the areas of applications, especially in case of large, bulky and heavy work pieces.



### An inspiring technology ...

The performance of the linear continuous feed systems is determined by the following equipment parameters:

- ▶ Size of the processing bowl
- ▶ Bowl inclination
- ▶ Amplitude/imbalance settings and RPM

The size of the processing bowl determines finishing performance to a large extent. The selection of the usable bowl width, available from 350 - 850 mm (14 - 34") depends mainly on the work piece dimensions. Different bowl lengths between 4,600 and 6,600 mm (173 - 260"),

the bowl inclination, adjustable imbalance units and the variable speed of the vibratory drive system determine the processing time. The final finishing results, however, depend to a large extent on the selection of the "right" Rösler grinding or polishing media.

## Efficient and sturdy vibratory drive ...

The specially designed vibratory drive system guarantees a continuously high performance! The adjustable imbalance units propelled by the powerful Rösler vibratory drive are mounted to the bottom of the processing bowl and are placed at an equal distance over the entire bowl length.

This vibratory drive combined with variable speed of the main drive will meet any surface finishing task, no matter how ambitious this may be.



Sturdy drive system, main drive

## The outside of the processing bowl ...

The welding construction of the processing bowl is made from special steel. Numerous reinforcing ribs and heat treatment of the entire bowl ensure a high resistance against stress from torsion and vibration.



Processing bowl from the outside

## A well thought out system ...

The dirty water drains of the processing bowl end in a collection chute mounted outside for easy access and maintenance. A lifting station with diaphragm pump is the central collection point for the dirty water in connection with a Rösler process water recycling filtering system.



Process water collection chute with lifting station

## An essential detail ...

The air cushion system acts as a vibration dampener and effectively prevents the vibrations from the processing bowl from transferring to the base frame.



Air cushion elements

## EFFICIENT OPERATION GUARANTEES LOW COSTS

The numerous technical characteristics of the Rösler linear continuous feed vibratory systems are a special focal point for our customers, for a highly flexible equipment concept is more important than ever!



### Uncompromised Engineering ...

The inclination feature for the processing bowl combined with adjustable imbalance units and the variable speed of the vibratory drive system allow a wide range of processing times. The bigger the work bowl inclination, the faster the travel speed through the processing bowl.

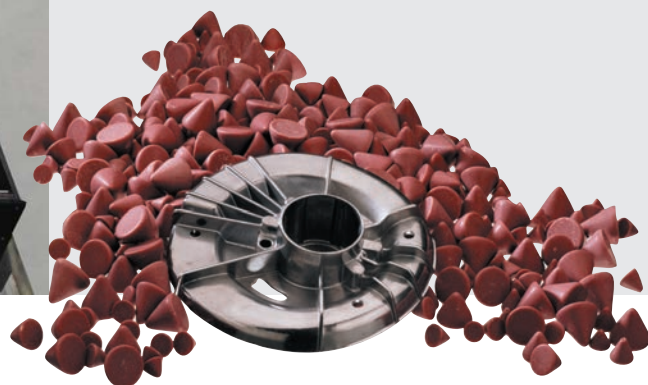

Eco plus cleaning system

### Absolutely clean work pieces - with a minimum of water usage

The finished work pieces can be rinsed off with fresh or cleaned process water during the separation phase on the vibratory screening unit.

The rinse water is then immediately re-used for the finishing process in the processing bowl. This multiple water use (Eco plus cleaning system) saves valuable resources.



## Programmable processing times ...

Electronic sensors monitor the inclination level of the processing bowl. Programs with individual processing times can be called up in the PLC.



Horizontal level of the processing bowl - medium processing time



Processing bowl raised at the bowl entrance - shorter processing times



Processing bowl raised at the bowl exit - longer processing times

## Processing of extra large work pieces ...

The discharge section at the bowl exit can be adapted to the size, weight and fragility of the work pieces. This allows trouble-free processing of work pieces with dimensions of up to 600 mm (24") – measured diagonally – and weights of up to 50 kg (110 lbs.).



Special bowl discharge section



## GENTLE AND RELIABLE SEPARATION OF HIGH VALUE WORK PIECES

The smooth, unproblematic separation of the media from the finished work pieces is key to a high machine performance and finishing quality. For this reason, our vibratory separation units are characterized by a very large, specially designed screening

area and a powerful vibratory drive resulting in an excellent separation performance. Only this guarantees the optimum utilization of the complete finishing system!

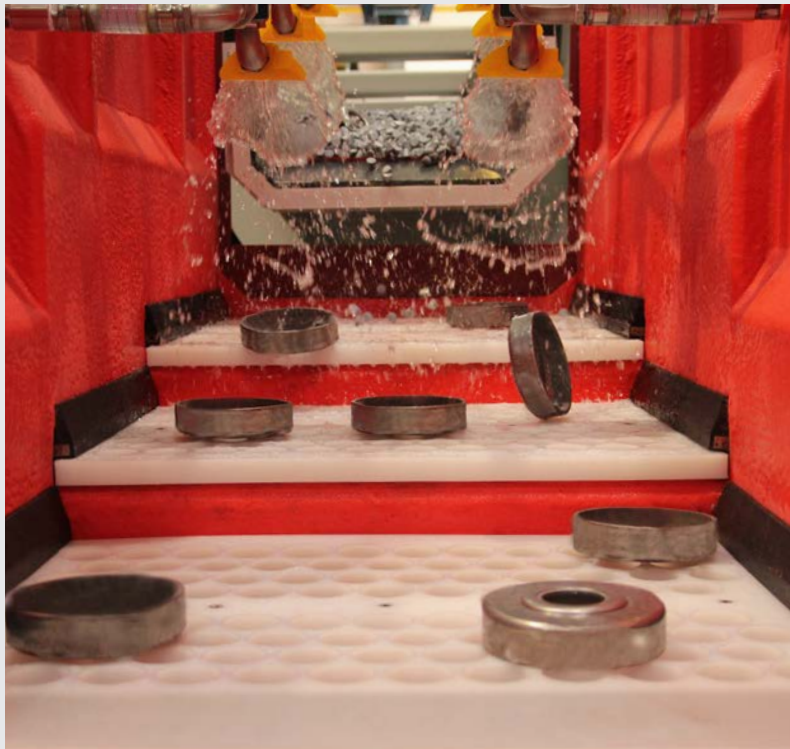

### Precise, flexible and fast ...

The vibratory separation unit, equipped with its own vibratory drive system, is entirely independent from the vibratory drive of the processing bowl. This guarantees an optimum separation operation for any application – irrespective of the work piece feeding rate and the operating conditions in the processing bowl. The following screen deck options are available:

- ▶ Tumbling steps with different standard step heights for removal of media from cup shaped work pieces
- ▶ Single level screen deck without any tumbling steps (option)
- ▶ The quick exchange of the separation screens without the requirement for any special tools allows the flexible adaptation to any separation task
- ▶ The fragility of the work pieces determines the screening intensity and speed. The screening speed is infinitely variable (option)
- ▶ Rinsing station for removal media residue from the finished work pieces

## Magnetic separation ... quick and efficient

For separating the media from the finished work pieces, which are similar in size or smaller than the media, the Rösler linear continuous feed systems can be supplied with one or two magnetic drum separators or a magnetic belt separator.

### Drum magnetic separator

Independent rotary drive: Powerful permanent magnet inside of the rotary drum; equipped with height adjustment and variable speed to prevent media carryout.

Tandem operation: Offers twice the separation performance! (two drum separators in sequence)

De-magnetizing: A patented de-magnetizing device in the drum body guarantees the safe and targeted discharge of the finished work pieces.

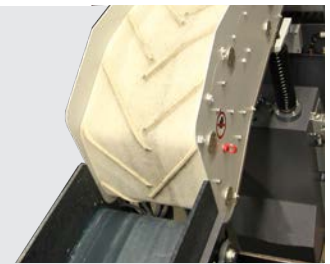

Magnetic belt separator



Dual magnetic drum separators

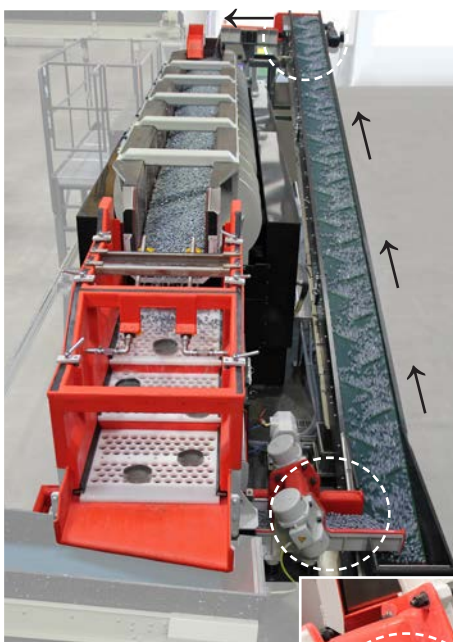

Media transport system



Lower vibratory cross conveyor with residual water screen segment and Media return belt conveyor

## A flexible media return system ...

The high performance media return system is a key factor for achieving the best possible finishing results regardless of the application. After the media is separated from the work pieces it passes onto a vibratory cross conveyor from where they are transferred to the angled media return belt conveyor. Residual process water is collected through special screen segments. The belt is equipped with special cams. Any remaining process water is collected in a collecting pan and pumped to the water treatment station. From the belt conveyor the media are passing to a vibratory cross conveyor that transfers them back into the processing bowl. An advantage of the Rösler system is that all media transfer points have minimum dropping heights so that the use of ceramic media poses no problem.

## Different work piece shapes and sizes ...

The screen decks can be easily be adapted to the different work piece shapes and sizes.

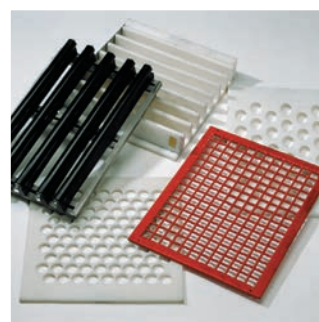

Screen deck versions

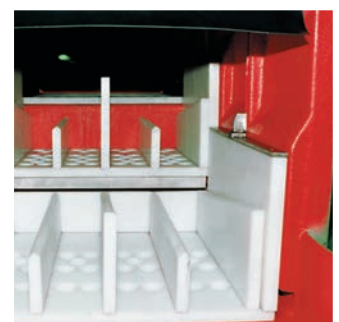

Special screen deck with tumbling steps for complex work piece shapes

# HIGH PRODUCTIVITY AND EASY MAINTENANCE

Rösler fully automatic linear continuous feed finishing systems are highly reliable! They guarantee excellent performance and uptimes with, at the same time, low costs for wear parts and maintenance.

Should a problem occur, our mobile professional service staff is available round the clock, and our parts service can quickly dispatch spare parts to any location in the world.

## Design details ... the results of our practical experience

A slide-in undersize media classification screen below the main screen deck removes small media that might otherwise get lodged in the work pieces. Easy accessibility to the undersize screen and its self-cleaning capability keep time needed for maintenance at a minimum.

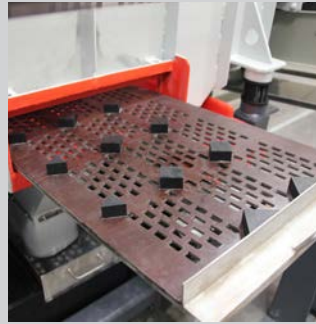

Undersize screen

## Automated maintenance ...

Automated supply of grease to the motor bearings in the vibratory drive system is controlled by the maintenance program in the PLC.



Central lubrication with Progressive distribution

## Short setup times ...

The media exchange system along with the inclination of the processing bowl allows a quick exchange of the media.

### Media change



Media unload gate

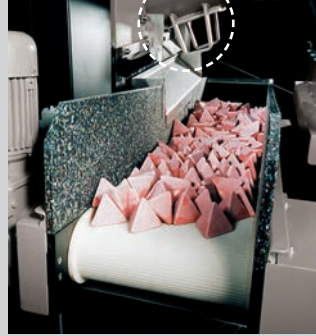

Media unload conveyor belt

## An agreeable working atmosphere ...

Upon request we can supply noise reducing cabins that are adapted to the machine site at the customer's premises.



# "INTELLIGENT" CONTROLS GUARANTEE TROUBLE – FREE OPERATION

The programmable logical controller (PLC) manages the complete finishing system.

## Programmable operation ...

Programmable electronic systems are the basis for today's system controls. The operation of finishing systems linked with work piece loading/unloading devices and post-treatment equipment can be programmed and monitored with the latest PLC technology. Specially designed operational programs allow the precise control of, for example, the speed of the various drives and the processing time. In addition, all important equipment functions are constantly monitored, including:

- ▶ Media return system
- ▶ Water and compound dosage
- ▶ The flow of process water (helps to prevent the machine from running "dry")
- ▶ Supply of compressed air
- ▶ Service intervals
- ▶ Rinsing station (optional)
- ▶ Work piece feeding: Transfer and post-treatment equipment



A wide variety of system controls

## Down to the last detail ...

The control valves for process water, rinsing and cleaning systems, along with the flow meters for process water and compound are arranged for easy access and operation. The same applies to the compressed air distribution.



Compressed air distribution, process water and compound dosage

## A FLEXIBLE EQUIPMENT CONCEPT – BASED ON CREATIVITY AND KNOWHOW

Whether operated inline in a manufacturing system or as stand-alone processing unit, the superior performance potential of the linear continuous feed vibratory finishing systems can only be exploited, when work piece loading/unloading devices and post-treatment equipment are directly

linked with the basic finishing system. Two equally important linking areas offer maximum flexibility in the design of the overall finishing system. For example, degreasing or washing to meet specified cleanliness standards: Washing machines can be linked directly with the linear continuous feed finishing system.

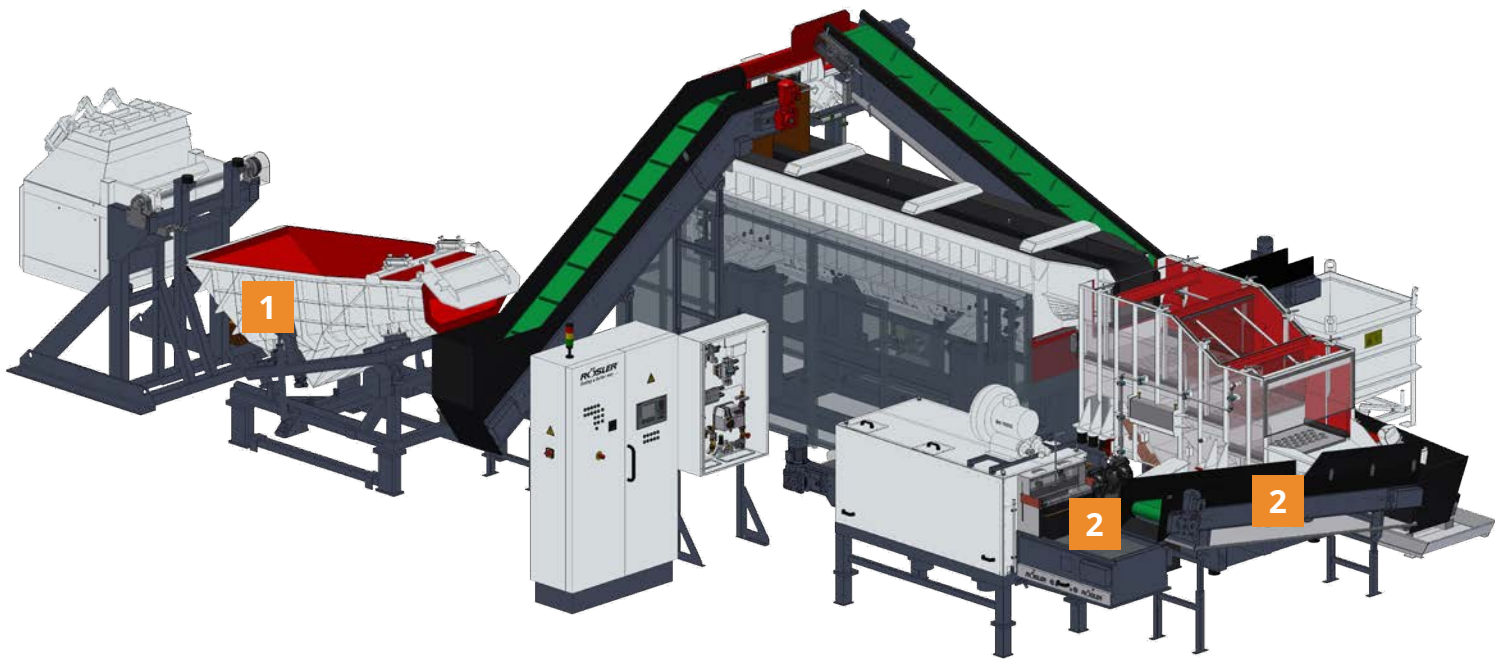

### Linking area **1** : Feeding of the raw parts

Various options are available for loading of the raw parts into the continuous finishing system. Available are lift & tip systems for transfer of the work pieces from the part bins to a feeding device. The combination of a vibratory buffer hopper with weighing cells allows the precise dosing of small bulk produced work pieces into the finishing system. Transport belts or roller conveyors with continuous or indexing movement can also be utilized.

### Linking area **2** : Post-treatment

Finished work pieces continuously discharged from the finishing machine can pass through various post-treatment systems fully automatically. Washing machines and passivation equipment from the portfolio of Rösler washing machines along with various drying systems are available. Automatic storage & transport devices and backfill units for the finished work pieces can be easily linked with other post-treatment equipment.



### Linking with a washing machine:

High performance washing systems are manufactured within the Rösler group.

## Supply of shot blast systems manufactured in-house:

Shot blasting and vibratory finishing combined into integrated surface treatment systems



### An intelligent combination ...

Shot blasting and mass finishing of aluminum die-castings:  
A work center consisting of a through feed tumble belt shot  
blast machine and a linear continuous feed finishing system.

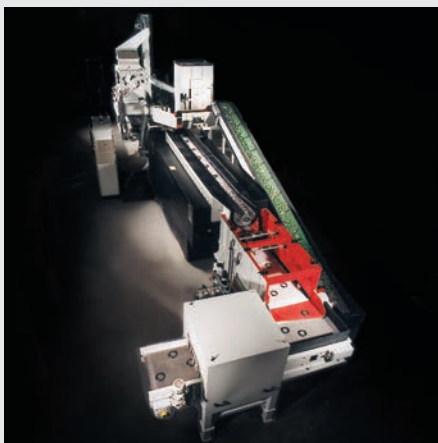

### Inline surface treatment ...

A Rösler continuous rubber conveyor belt machine and a linear  
continuous feed finishing system for transmission components.

## AUTOMATION SAVES COSTS

Individual equipment concepts with a high degree of operational flexibility and automation are key customer requirements in today's industrial environment. Our project teams support

you to ensure that all process and equipment related technical aspects are reflected in the final equipment concept.

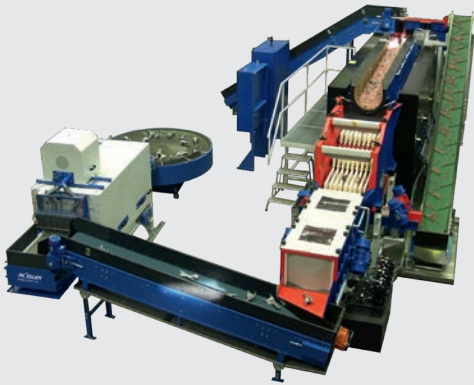

Linear continuous feed finishing system for processing aluminum die-castings: Work piece loading belt, spray rinse station for the finished work pieces, intermediate transport belt, hot air belt dryer, rotary storage table.



Linear continuous feed finishing system with work piece loading, vibratory feed hopper with weighing cells and loading belt, hot air belt dryer, cooling station, work piece buffer station.

Linear continuous feed deburring system, linked with several machining centers for grey iron castings weighing up to 50 kg (110 lbs.). Equipped with heavy duty buffering belt for the finished work pieces:

- 1 Buffer roller conveyor for raw work pieces
- 2 Lifting device equipped with in-feed roller conveyor
- 3 Linear continuous feed finishing system
- 4 Heavy duty buffering belt for the finished work pieces

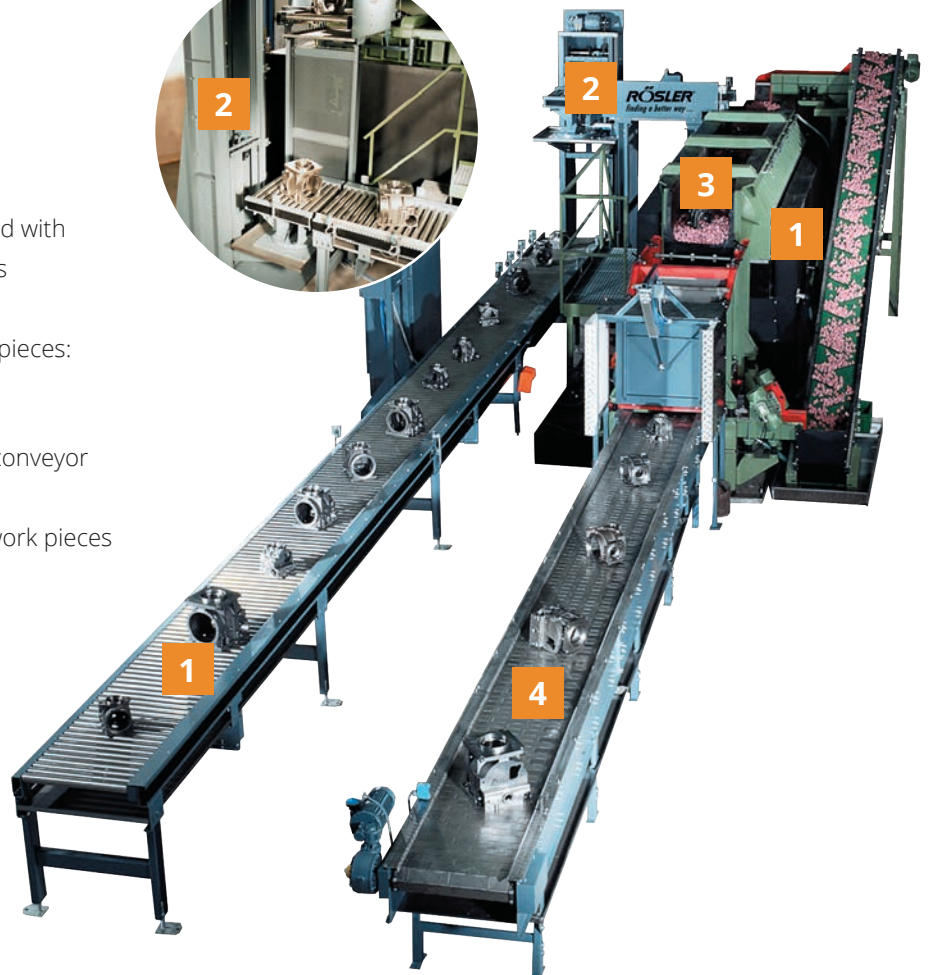



## High-Speed linear continuous feed system with 3,000 RPM

The highest possible work piece throughput is the most important design criterion for inline manufacturing. The performance of linear continuous feed systems for deburring, surface

grinding, cleaning and ball burnishing processes can be nearly doubled by running the vibratory drive at a speed of 3,000 RPM.



High-Speed linear continuous feed ball burnishing system

Processing media:  
Stainless steel satellites



Linear, continuous feed system, immersion bath for corrosion protection, vibratory work piece turning station.

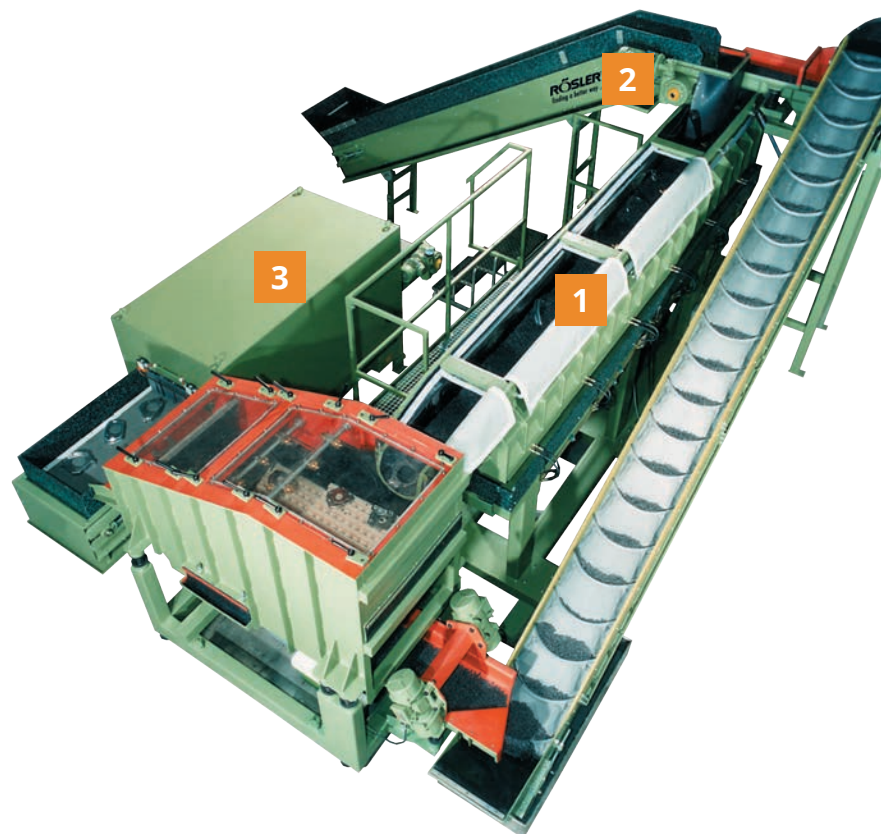

High-Speed linear continuous feed system 3000 **1** with angled vibratory screening station with tumbling steps, integrated work piece loading conveyor for the raw work pieces **2** and hot air belt dryer **3**

# TOP PERFORMANCE – WITH A SMALL FOOTPRINT

The Rösler linear continuous feed finishing systems can be supplied with different processing bowl widths and lengths. Special equipment versions for ball burnishing or High-Speed

mass finishing at 3,000 RPM are also available. We would love to demonstrate the high productivity of our machines to you in one of our test centers!

## Our equipment range – Linear, continuous feed systems (1500)

### Technical data

Model	R 425/4600 DA	R 425/6600 DA	R 550/4600 DA	R 550/6600 DA
A (mm)	4,600	6,600	4,600	6,600
B (mm)	330	330	430	430
C (mm)	2,800	2,800	3,080	3,080
D (mm)	425	425	550	550
E (mm)	7,400	9,400	8,100	10,500
F (mm)	2,100	2,100	2,250	2,250
G (mm)	2,750	2,750	2,950	2,950
H (mm)	890	890	1,050	1,050
Total installed power (kW)	22.3	22.3	25.1	29.1
Vibratory drive (kW)	18	18	18	22

### Technical data

Model	R 650/4600 DA	R 650/6600 DA	R 850/4600 DA	R 850/6600 DA
A (mm)	4,600	6,600	4,600	6,600
B (mm)	500	500	680	680
C (mm)	3,080	3,080	3,400	3,400
D (mm)	650	650	850	850
E (mm)	8,100	10,500	8,400	10,400
F (mm)	2,300	2,300	2,650	2,650
G (mm)	2,900	2,900	3,300	3,300
H (mm)	1,050	1,050	1,100	1,100
Total installed power (kW)	25.1	29.1	48.72	48.72
Vibratory drive (kW)	18	22	40	40

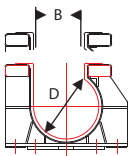

Cross section processing channel

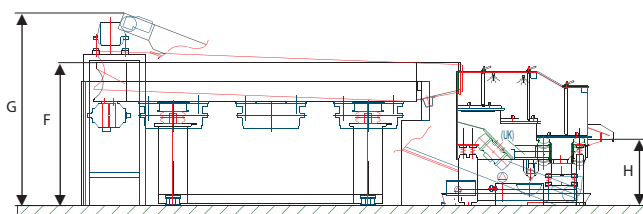

Side view

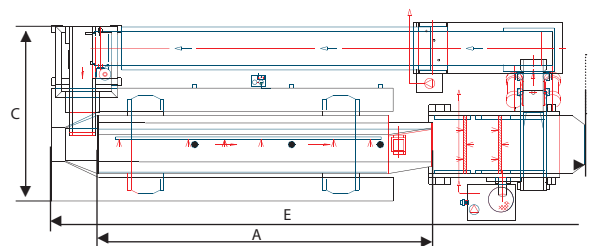

Top view

## Our equipment range – Linear continuous feed systems 3000 High-Speed

### Technical data

Model	R 300/4400 DA/KP	R 300/6400 DA/KP	R 350/4400 DA/KP	R 350/6400 DA/KP
A (mm)	4.400	6.400	4.400	6.400
B (mm)	240	240	290	290
C (mm)	1.800	1.800	1.850	1.850
D (mm)	300	300	350	350
E (mm)	7.600	9.600	7.700	9.700
F (mm)	1.600	1.600	1.680	1.680
G (mm)	2.500	2.500	2.500	2.500
H (mm)	890	890	890	890
Gesamtleistung (KW)	24	24	24	24
Hauptantrieb (KW)	18,5	18,5	18,5	18,5

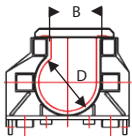

Cross section processing channel

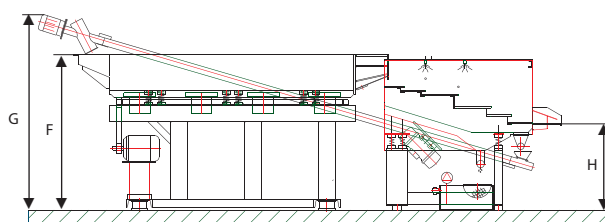

Side view

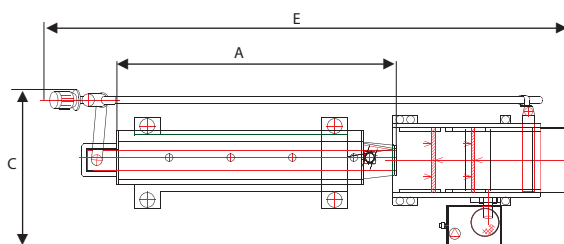

Top view

Mass Finishing  
Shot Blasting  
AM Solutions  
www.rosler.com

#### Germany

**Rösler Oberflächentechnik GmbH**  
Werk Memmelsdorf  
Vorstadt 1  
D-96190 Untermmerzbad  
Tel.: +49 9533 / 924-0  
Fax: +49 9533 / 924-300  
info@rosler.com

**Rösler Oberflächentechnik GmbH**  
Werk Hausen  
Hausen 1  
D-96231 Bad Staffelstein  
Tel.: +49 9533 / 924-0  
Fax: +49 9533 / 924-300  
info@rosler.com

#### USA

**Rösler Metal Finishing USA, L.L.C.**  
1551 Denso Road  
USA-Battle Creek  
MI 49037  
Tel.: +1 269 / 4413000  
Fax: +1 269 / 4413001  
rosler-us@rosler.com

#### France

**Rösler France**  
Z.I. de la Fontaine d'Azon  
CS 50513 – St. Clément  
F-89105 Sens Cedex  
Tel.: +33 3 / 86647979  
Fax: +33 3 / 86655194  
rosler-fr@rosler.com

#### Italy

**Rösler Italiana S.r.l.**  
Via Elio Vittorini 10/12  
I-20863 Concorezzo (MB)  
Tel.: +39 039 / 611521  
Fax: +39 039 / 6115232  
rosler-it@rosler.com

#### Switzerland

**Rösler Schweiz AG**  
Staffelbachstraße 189  
Postfach 81  
CH-5054 Kirchleerau  
Tel.: +41 62 / 7385500  
Fax: +41 62 / 7385580  
rosler-ch@rosler.com

#### Spain

**Rösler International GmbH & Co. KG**  
Sucursal en España  
Polg. Ind. Cova Solera C/Roma, 7  
E-08191 Rubí (Barcelona)  
Tel.: +34 93 / 5885585  
Fax: +34 93 / 5883209  
rosler-es@rosler.com

#### Netherlands

**Rösler Benelux B.V.**  
Reggestraat 18  
NL-5347 JG Oss  
Postbus 829  
NL-5340 AV Oss  
Tel.: +31 412 / 646600  
Fax: +31 412 / 646046  
rosler-nl@rosler.com

#### Belgium

**Rösler Benelux B.V.**  
Avenue de Ramelot 6  
Zoning Industriel  
B-1480 Tubize (Saintes)  
Tel.: +32 2 / 3610200  
Fax: +32 2 / 3612831  
rosler-be@rosler.com

#### Austria

**Rösler Oberflächentechnik GmbH**  
Hetmanekgasse 15  
A-1230 Wien  
Tel.: +43 1 / 6985180-0  
Fax: +43 1 / 6985182  
rosler-at@rosler.com

#### Romania

**Rösler Romania SRL**  
Str. Avram Iancu 39-43  
RO-075100 Otopeni/ILFOV  
Tel.: +40 21 / 352 4416  
Fax: +40 21 / 352 4935  
rosler-ro@rosler.com

#### Russia

**Rösler Russland**  
Borovaya Str. 7, bldg. 4, office 107  
111020 Moscow  
Tel. / Fax: +7 495 / 247 55 80  
rosler-ru@rosler.com

#### Great Britain

**Rösler UK Ltd.**  
Unity Grove, School Lane  
Knowsley Business Park  
GB-Prescot, Merseyside L34 9GT  
Tel.: +44 151 / 4820444  
Fax: +44 151 / 4824400  
rosler-uk@rosler.com

#### Brazil

**Rösler Otec do Brasil LTDA**  
Av. Antonio Angelo Amadio, 1421  
Centro Empresarial Castelo Branco  
18550-000 Boituva  
São Paulo - Brasil  
Tel.: +55 15 / 3264-1117  
Tel.: +55 15 / 3264-1112  
info@rosler-otec.com.br

#### China

**Rösler SURFACE-TECH (BEIJING) CO., LTD.**  
Beijing Office  
Fu Hua Mansion, Office A-11-K  
No. 8, Chao Yang Men North Avenue  
Beijing 100027, P.R. China  
Tel.: +86 10 / 6554 73 86  
Fax: +86 10 / 6554 73 87  
rosler-cn@rosler.com

and over 150 additional distributors  
around the world



Find your contact